

2W Q Band High Power Amplifier

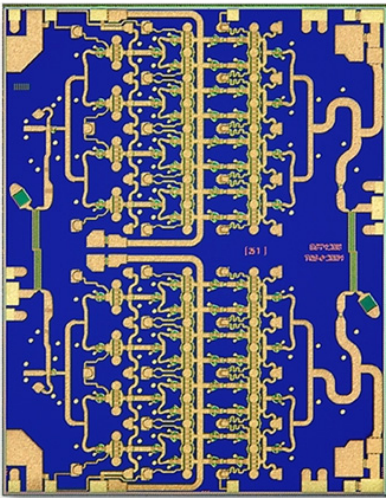

Key Features

- Typical Frequency Range: 41 - 46 GHz
- Typical 33dBm Psat, 32dBm P1dB
- 17 dB Nominal Gain
- 16 dB Nominal Return Loss
- Bias: 6 V, 2 A
- 0.15 um 3MI pHEMT Technology
- Chip Dimensions 3.45 x 4.39 x 0.10 mm (0.136 x 0.173 x 0.004 in)

Primary Applications

- Sat - Com

Product Description

The TriQuint TGA4046 is a compact High Power Amplifier MMIC for Q-band applications. The part is designed using TriQuint's 0.15um gate power pHEMT process.

The TGA4046 nominally provides 33dBm of Saturated Output Power, and 32dBm Output Power at 1dB gain compression from 41 - 46GHz. The MMIC also provides 17dB Gain and 16dB Return Loss.

The part is ideally suited for markets such as Satellite Communications both commercial and military.

The TGA4046 is 100% DC and RF tested on-wafer to ensure performance compliance.

Lead-Free & RoHS compliant.

Measured Fixtured Data

Bias Conditions: $V_d = 6\text{ V}$, $I_d = 2\text{ A}$

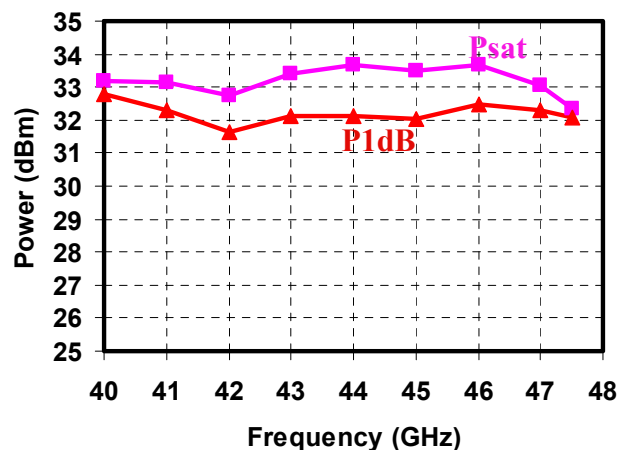
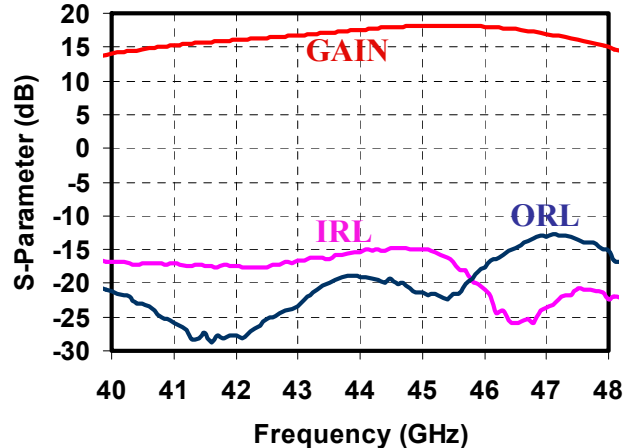

Datasheet subject to change without notice

TABLE I
MAXIMUM RATINGS 1/

SYMBOL	PARAMETER	VALUE	NOTES
V _d	Drain Voltage	6.5 V	<u>2/</u>
V _g	Gate Voltage Range	-2 TO 0 V	
I _d	Drain Current	3 A	<u>2/ 3/</u>
I _g	Gate Current	112 mA	<u>3/</u>
P _{IN}	Input Continuous Wave Power	29 dBm	
P _D	Power Dissipation	19.5 W	<u>2/ 4/</u>
T _{CH}	Operating Channel Temperature	200 °C	<u>5/ 6/</u>
	Mounting Temperature (30 Seconds)	320 °C	
T _{STG}	Storage Temperature	-65 to 150 °C	

- 1/ These ratings represent the maximum operable values for this device.
- 2/ Combinations of supply voltage, supply current, input power, and output power shall not exceed P_D.
- 3/ Total current for the entire MMIC.
- 4/ When operated at this bias condition with a base plate temperature of 70 °C, the median life is 1.9E5 hrs.
- 5/ Junction operating temperature will directly affect the device median time to failure (T_m). For maximum life, it is recommended that junction temperatures be maintained at the lowest possible levels.
- 6/ These ratings apply to each individual FET.

TABLE II
ELECTRICAL CHARACTERISTICS
 (Ta = 25 °C Nominal)

PARAMETER	TYPICAL	UNITS
Frequency Range	41 - 46	GHz
Drain Voltage, Vd	6.0	V
Drain Current, Id	2	A
Gate Voltage, Vg	-0.6	V
Small Signal Gain, S21	17	dB
Input Return Loss, S11	18	dB
Output Return Loss, S22	20	dB
Output Power @ 1dB Gain Compression, P1dB	32	dBm
Saturated Power, Psat	33	dBm

**TABLE III
THERMAL INFORMATION**

PARAMETER	TEST CONDITIONS	T _{CH} (°C)	θ _{JC} (°C/W)	T _m (HRS)
θ _{JC} Thermal Resistance (channel to Case)	V _d = 6 V I _d = 2 A P _{diss} = 12 W	129	4.9	6.4E+6

Note: Assumes eutectic attach using 1.5 mil 80/20 AuSn mounted to a 20 mil CuMo Carrier at 70 °C baseplate temperature. Worst case condition with no RF applied, 100% of DC power is dissipated.

Median Lifetime (T_m) vs. Channel Temperature

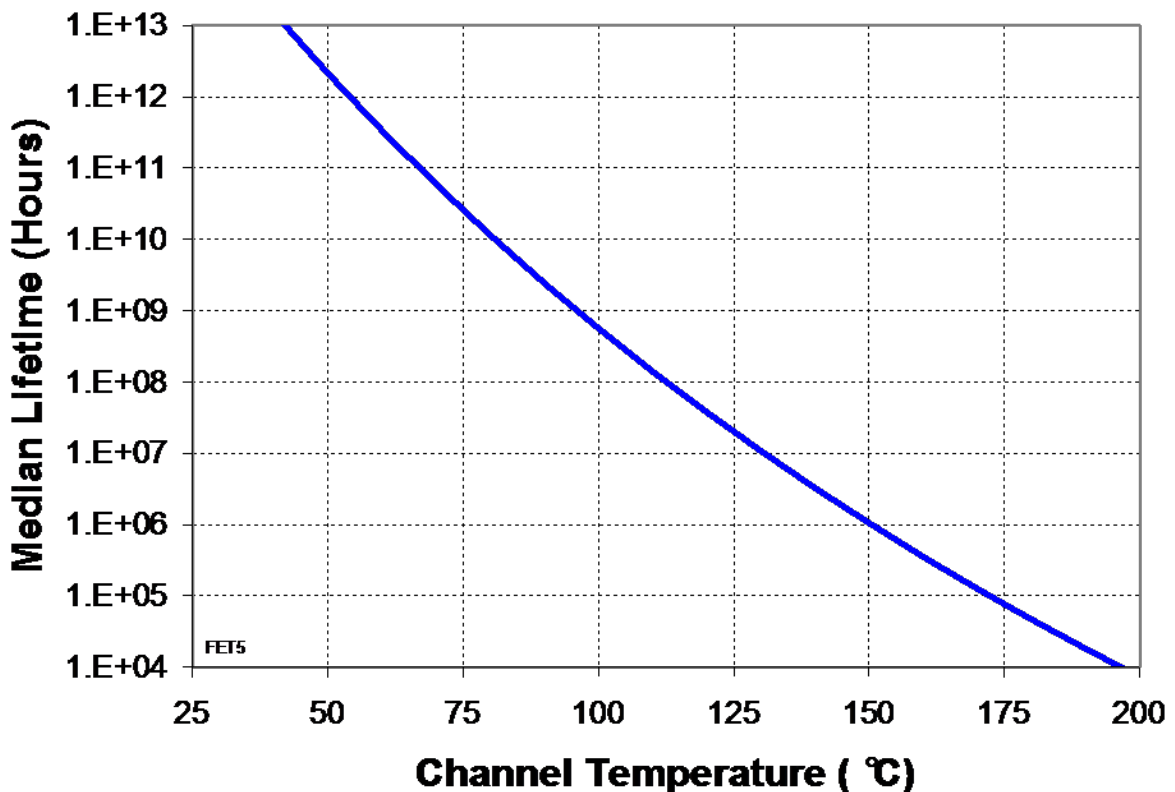

Measured Data

Bias Conditions: $V_d = 6\text{ V}$, $I_d = 2\text{ A}$

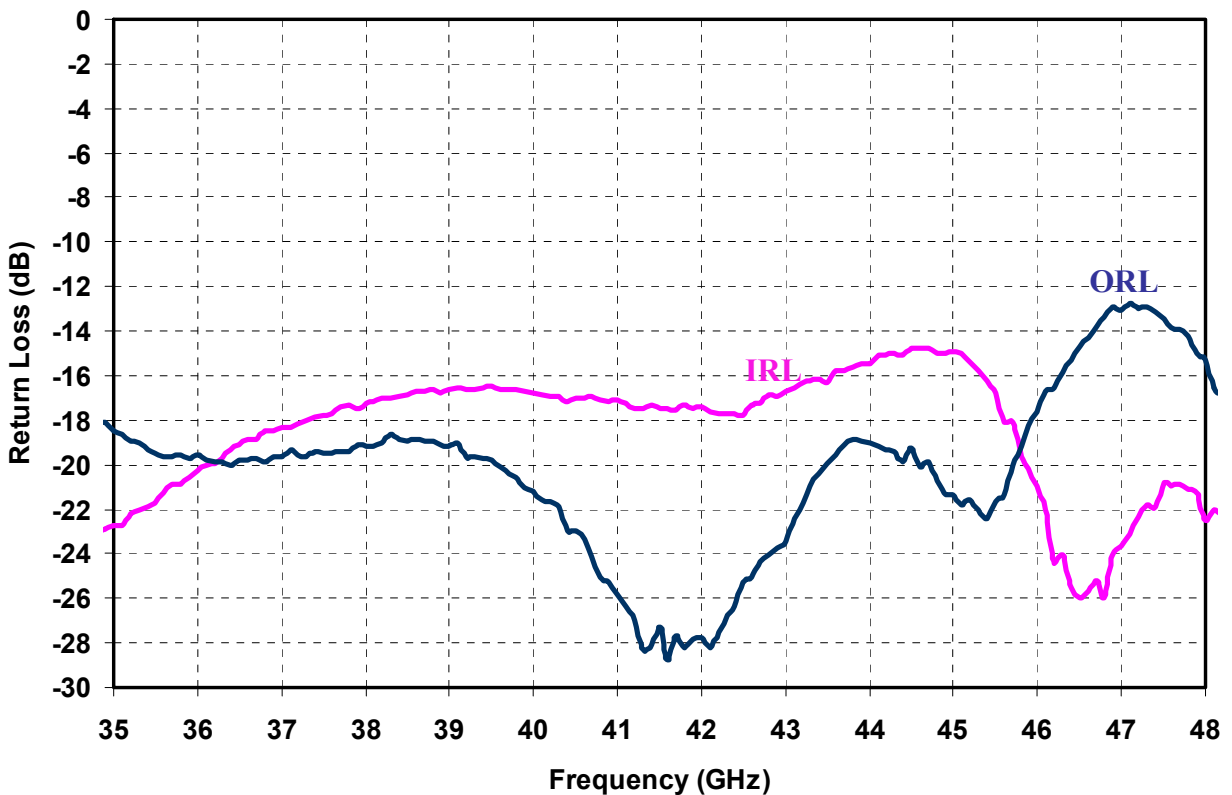
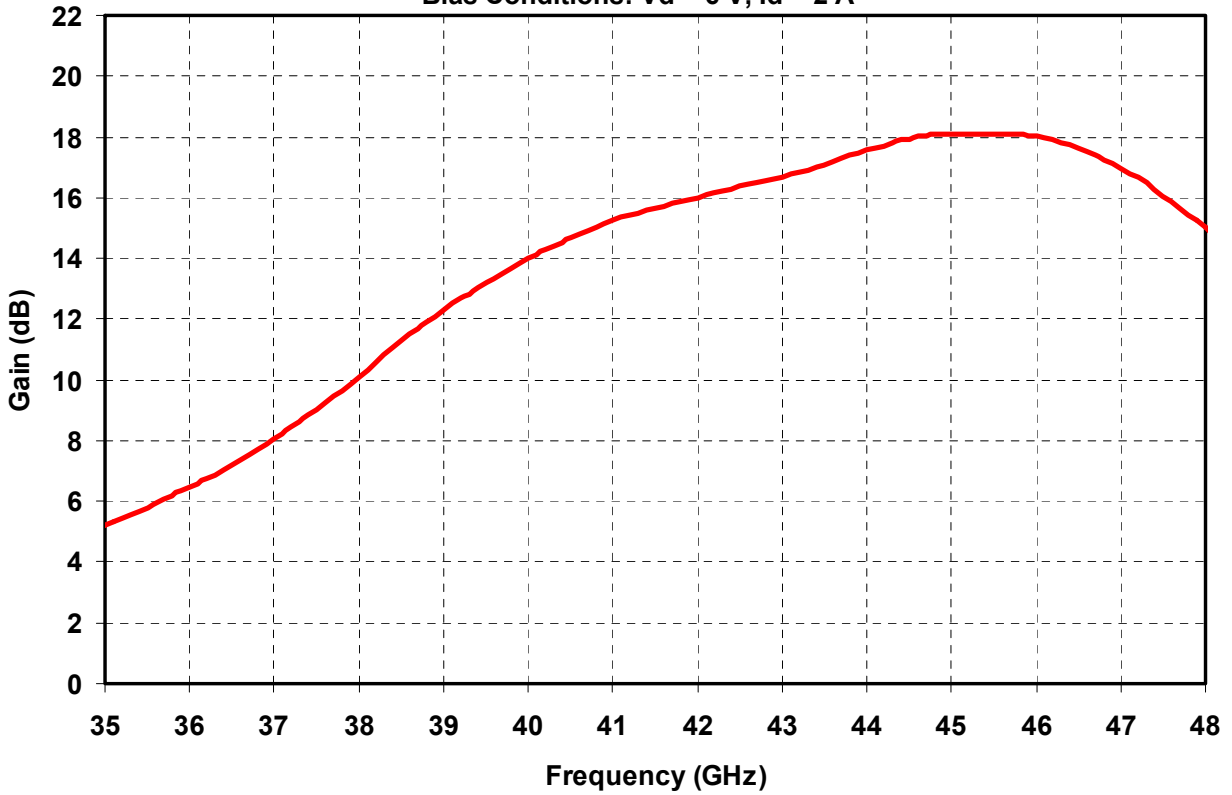

Measured Data

Bias Conditions: $V_d = 6\text{ V}$, $I_d = 2\text{ A}$

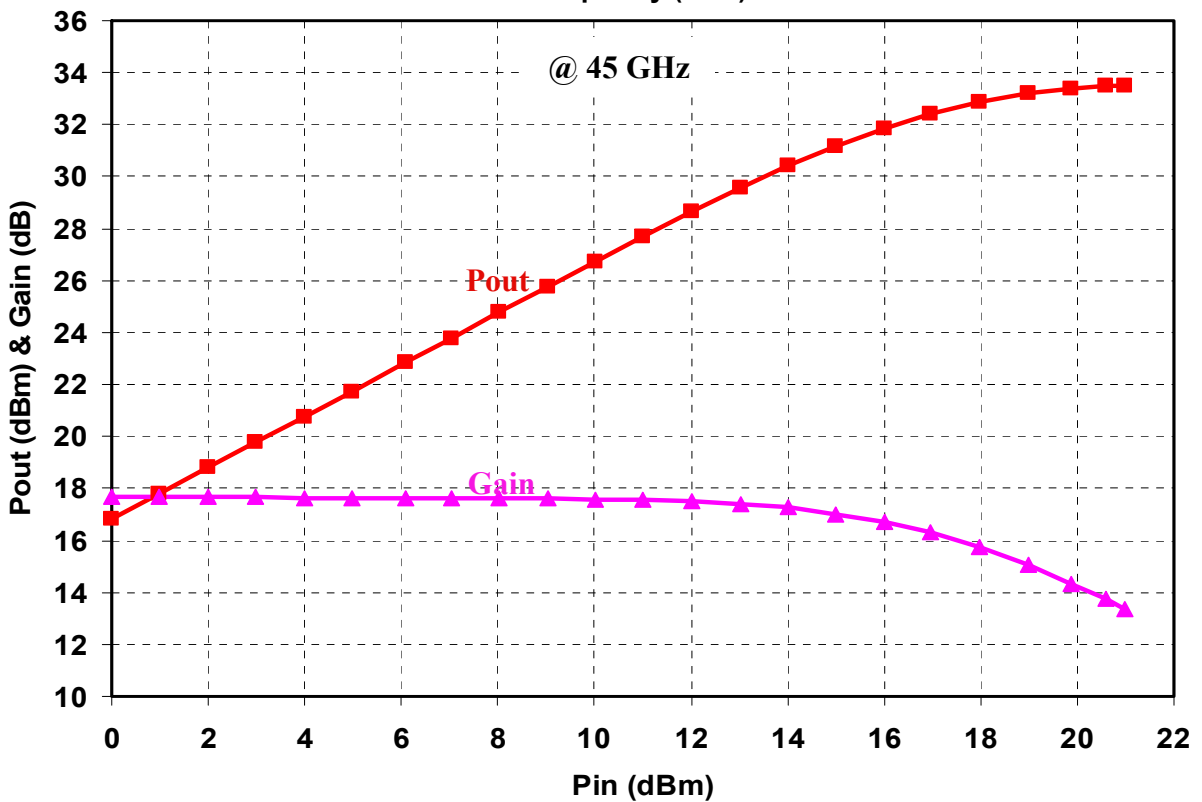
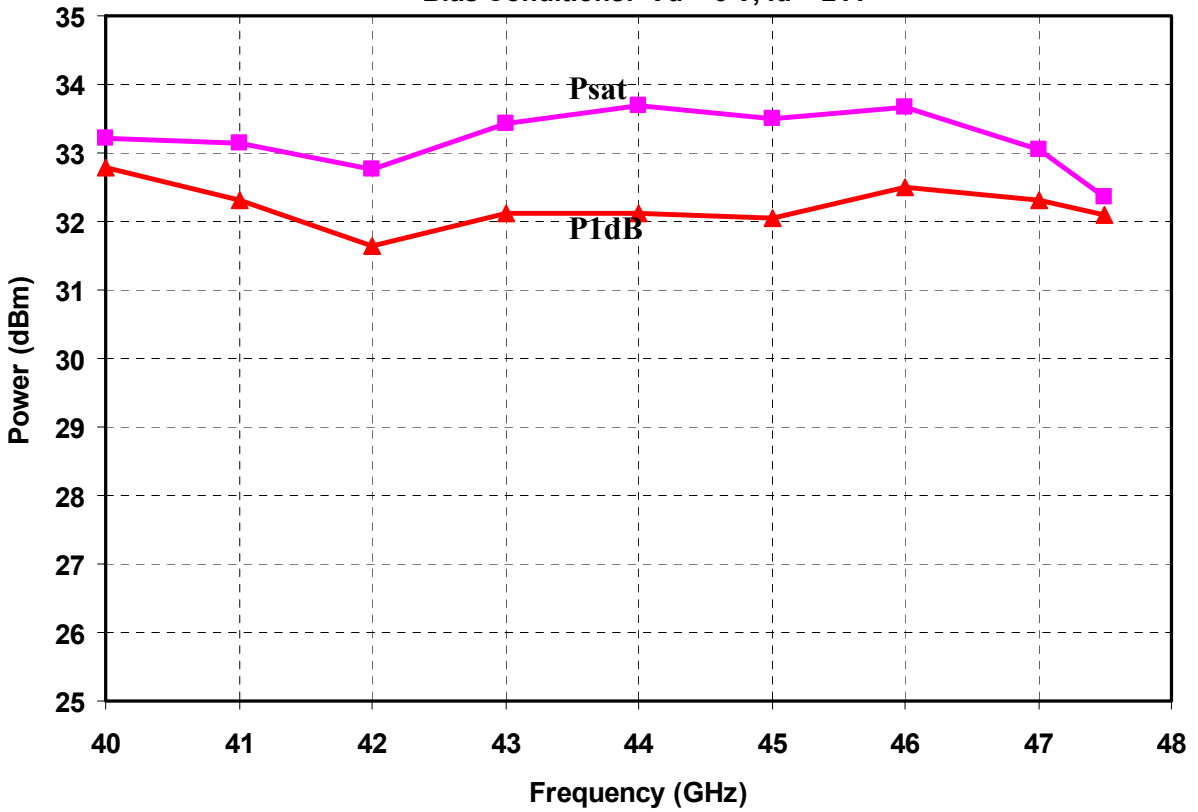

Mechanical Drawing

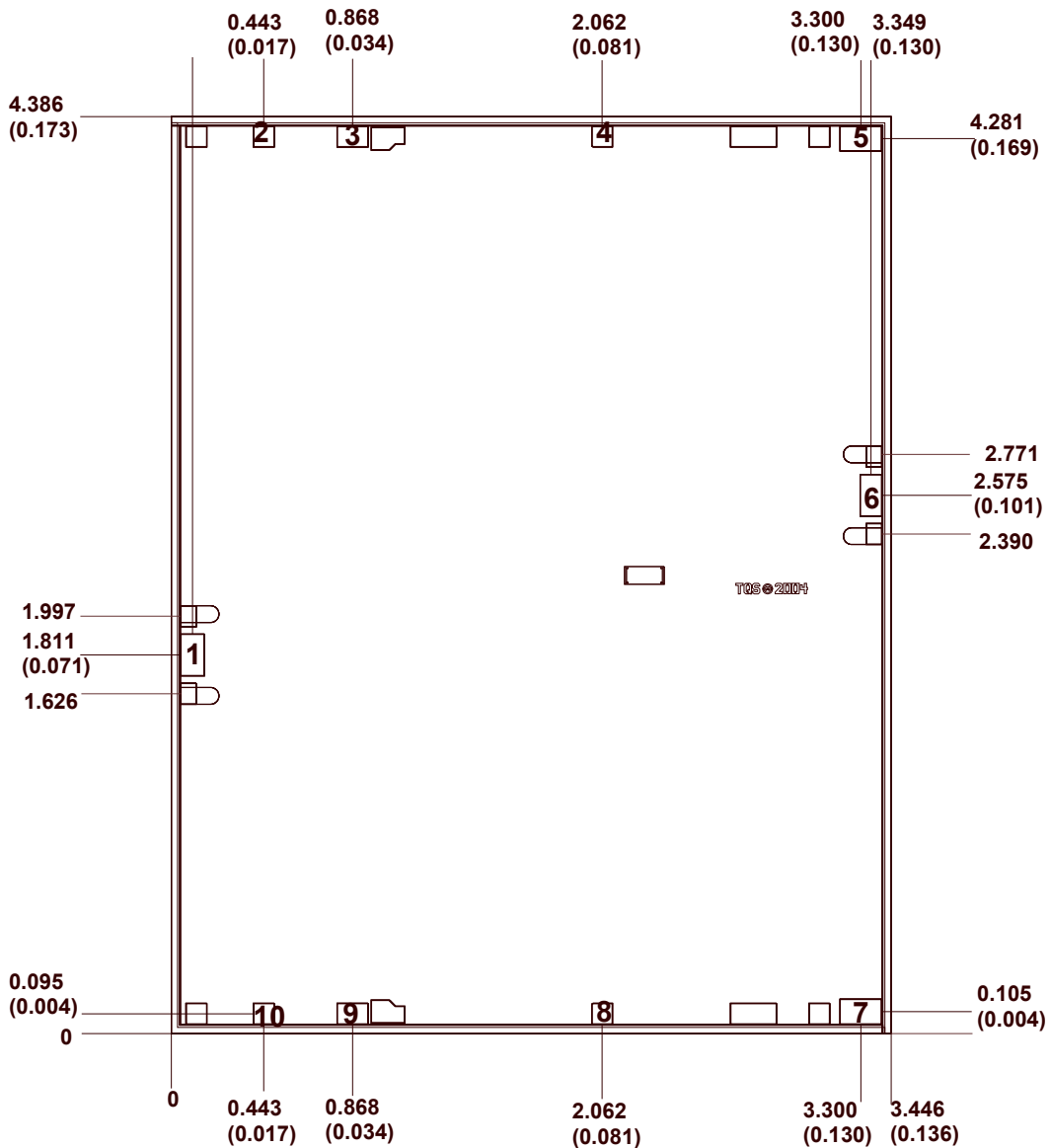

Units: millimeters (inches)

Thickness: 0.100 (0.004)

Chip edge to bond pad dimensions are shown to center of bond pad

Chip size tolerance: +/- 0.051 (0.002)

GND is back side of MMIC

Bond pad #1:	(RF In)	0.114 x 0.200 (0.004 x 0.008)
Bond pad #2, #4, #8, #10:	(Vg)	0.100 x 0.100 (0.004 x 0.004)
Bond pad #3, #9:	(Vd)	0.150 x 0.100 (0.006 x 0.004)
Bond pad #5, #7:	(Vd)	0.200 x 0.120 (0.008 x 0.005)
Bond pad #6:	(RF Out)	0.105 x 0.200 (0.004 x 0.008)

GaAs MMIC devices are susceptible to damage from Electrostatic Discharge. Proper precautions should be observed during handling, assembly and test.

Recommended Chip Assembly Diagram

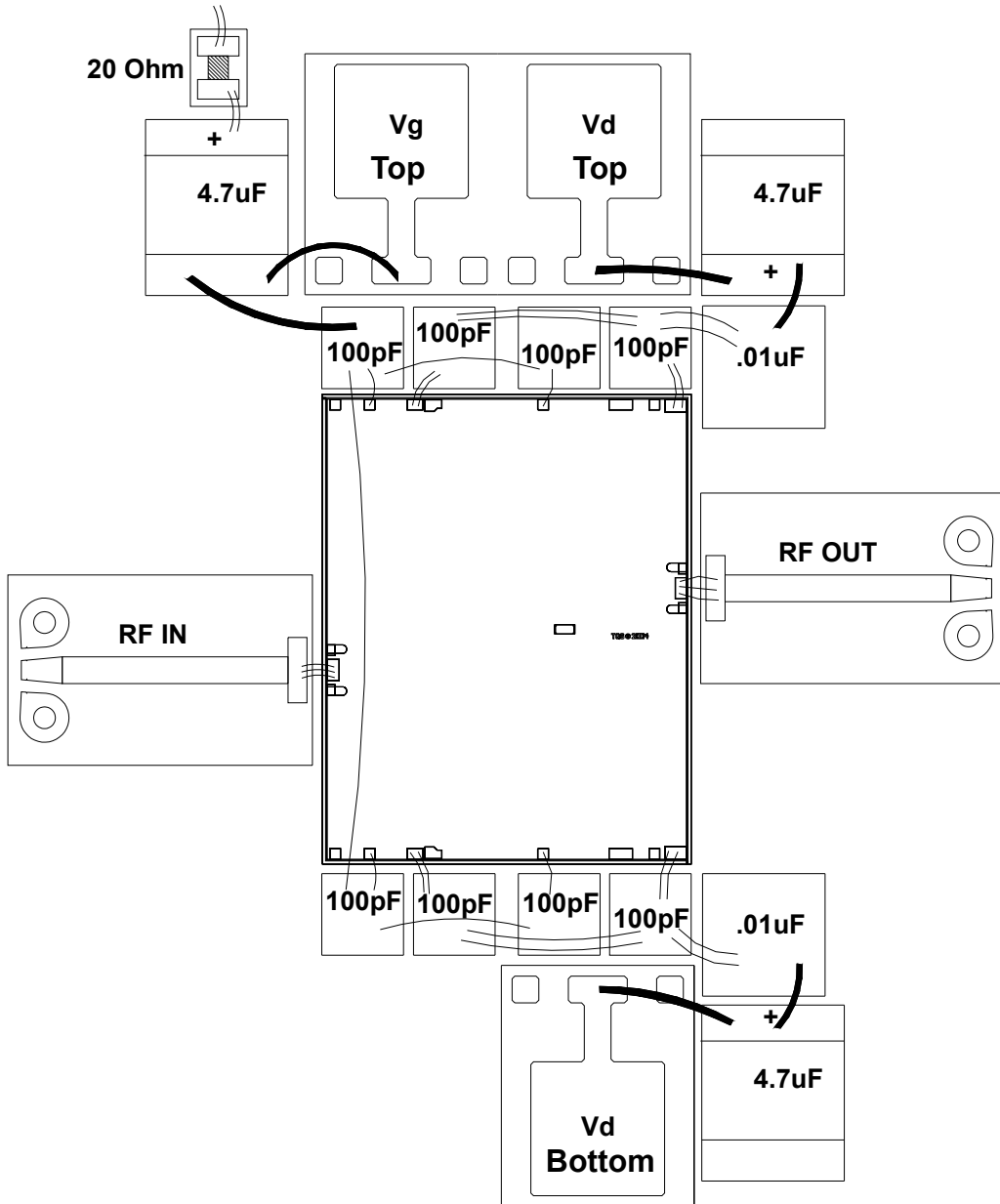

The substrates at both RF in and RF out end at the MMIC with a flare (0.01 x 0.03 in) on 0.01 in thick Alumina. The gate bias, Vg, can be applied to pin 10 at bottom of MMIC, in lieu of the long bond wire across the MMIC. The large value capacitors on Vd and Vg ensure low frequency stability.

GaAs MMIC devices are susceptible to damage from Electrostatic Discharge. Proper precautions should be observed during handling, assembly and test.

Recommended Test Setup Diagram

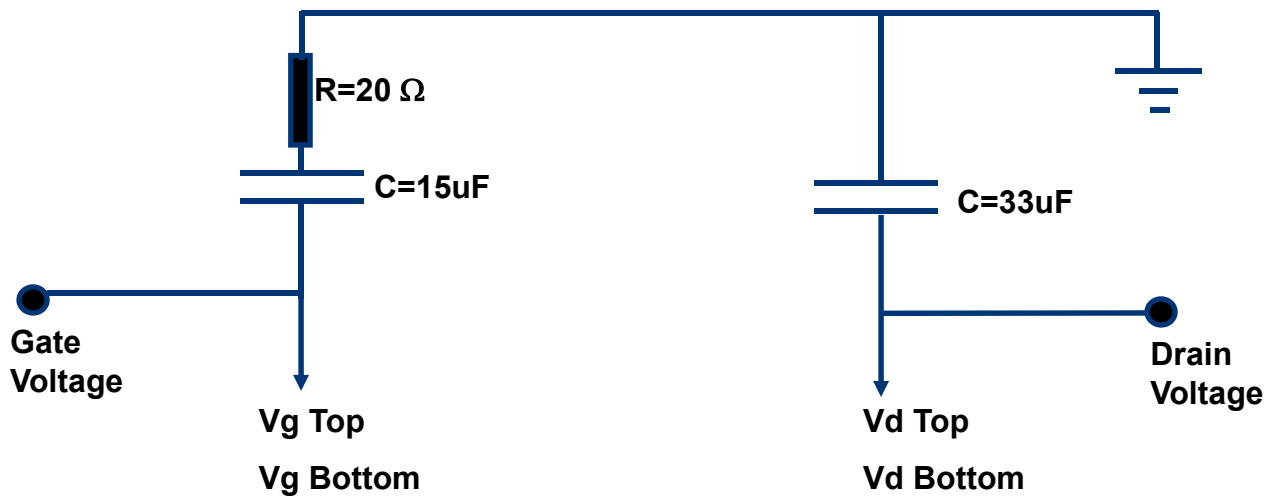

Biassing setup procedures

- (1) Recommend use conductive thermal grease underneath carrier for proper operation. Also use cooling fan to improve heat dissipation.
- (2) Before applying bias, set gate supply voltage to -1.5V and current limit to 4mA on each half of the amplifier, then apply the bias to gate.
- (3) Set drain supply voltage to 1V and current limit to 1.6A on each half of the amplifier, then apply the bias to drain.
- (4) Slowly increase the gate supply voltage and check the drain current, if drain current slowly increases, then increase drain supply voltage slowly to 6V.
- (5) Slowly adjust gate supply voltage to obtain a drain current of 1A quiescent on each half of the amplifier.

Assembly Process Notes

Reflow process assembly notes:

- Use AuSn (80/20) solder with limited exposure to temperatures at or above 300⁰C (30 seconds max).
- An alloy station or conveyor furnace with reducing atmosphere should be used.
- No fluxes should be utilized.
- Coefficient of thermal expansion matching is critical for long-term reliability.
- Devices must be stored in a dry nitrogen atmosphere.

Component placement and adhesive attachment assembly notes:

- Vacuum pencils and/or vacuum collets are the preferred method of pick up.
- Air bridges must be avoided during placement.
- The force impact is critical during auto placement.
- Organic attachment can be used in low-power applications.
- Curing should be done in a convection oven; proper exhaust is a safety concern.
- Microwave or radiant curing should not be used because of differential heating.
- Coefficient of thermal expansion matching is critical.

Interconnect process assembly notes:

- Thermosonic ball bonding is the preferred interconnect technique.
- Force, time, and ultrasonics are critical parameters.
- Aluminum wire should not be used.
- Maximum stage temperature is 200⁰C.

GaAs MMIC devices are susceptible to damage from Electrostatic Discharge. Proper precautions should be observed during handling, assembly and test.